



BLACK SERIES





A TERMOFOC projecta e fabrica recuperadores de calor e salamandras a biomassa, aliando a eficiência com o design na procura constante da inovação.

Por isso criamos uma nova linha de recuperadores e salamandras, tecnicamente concebidos para consumir menos lenha e produzir mais calor com menos emissões de CO<sub>2</sub>, tornando-se assim mais amigos do ambiente.

Esta evolução técnica tinha que ter uma imagem adequada "BLACK SERIES", que apresenta recuperadores e salamandras criados com um design perfeito para o fazer sentir o prazer da chama.

La compañía TERMOFOC diseña y manufactura recuperadores y estufas a biomasa, combinando eficiencia con diseño y buscando constantemente la innovación.

Para ello hemos creado una línea de recuperadores y de estufas técnicamente concebidos para consumir menos leña produciendo más calor con reducidos niveles de emisión de CO<sub>2</sub>, tornándose así más respetuosos con el medio ambiente.

Esta evolución técnica requería una imagen adecuada "BLACK SERIES", que presenta recuperadores y estufas creados con un diseño perfecto para te hacer sentir el placer de la llama.





VISÃO GERAL  
VISIÓN GENERAL



LISBOA 700 EA



LISBOA 800 EA



LISBOA 900 EA



LISBOA 900 DF EA



FARO 500 EA



FARO 600 EA



FARO 700 EA



FARO 800 EA



FARO 900 EA



FARO 600 DF EA



FARO 900 DF EA



LISBOA SL 700 EA



LISBOA SL 800 EA



LISBOA SL 900 EA



FARO SL 500 EA



FARO SL 600 EA



FARO SL 700 EA



FARO SL 800 EA



FARO SL 900 EA



## PORMENORES TÉCNICOS DETALLES TECNICOS



SAÍDA DE AR PARA DUPLA COMBUSTÃO, GARANTE UM CONTROLO DE CHAMA MAIS EFICAZ  
SALIDA DE AIRE PARA COMBUSTIÓN DOBLE, GARANTIZANDO UN CONTROL MÁS EFICAZ DE LA LLAMA



PUXADOR INOX  
MANILLA EN ACERO INOX



INTERIOR DA PORTA COM ACABAMENTO INOX  
INTERIOR DE LA PUERTA CON REMATE INOX



SAÍDAS DE AR PARA MANTER O VIDRO LIMPO  
SALIDAS DE AIRE PARA MANTENER EL CRISTAL LIMPIO



INTERRUPTOR DE VENTILAÇÃO, QUE PERMITE DESLIGAR OS VENTILADORES  
INTERRUPTOR DE VENTILACIÓN, PARA DESLIGAR LOS VENTILADORES



ENTRADA DE AR EXTERIOR PARA A COMBUSTÃO. GARANTE SEMPRE A QUALIDADE DO AR DA SUA HABITAÇÃO  
ENTRADA DE AIRE EXTERIOR PARA LA COMBUSTIÓN. GARANTIZA SIEMPRE LA CALIDAD DEL AIRE DE LA VIVIENDA



## LISBOA 700 EA

Equipamentos com design moderno e requintado, com um toque especial em inox na porta e no puxador. Os recuperadores BLACK SERIES têm uma ampla visão de chama, mantendo baixo consumo de lenha, com elevado rendimento. A tripla combustão garante uma chama perfeita e controlada. Os ventiladores são tangenciais de elevado desempenho e silenciosos, com duas velocidades, para melhorar o seu conforto. A entrada de ar do exterior direta ao recuperador vai beneficiar a qualidade do ar da sua habitação, evitando problemas de funcionamento por depressão.

Equipos de diseño moderno y refinado, con un toque especial en inox en la puerta y manilla. Los recuperadores BLACK SERIES tienen una amplia visión de la llama, manteniendo un bajo consumo de leña, con elevada fuente de calor. La combustión triple garantiza una llama perfecta y controlada. Los ventiladores son tangenciales de elevado desempeño y silenciosos, con dos velocidades para mejorar el confort. La entrada de aire exterior directamente hacia el recuperador va beneficiar la calidad del aire del hogar, y evitar problemas de funcionamiento por vacío.

CARACTERÍSTICAS:	LISBOA 700 EA	LISBOA 800 EA	LISBOA 900 EA
Combustível Combustible	Lenha Leña	Lenha Leña	Lenha Leña
Potência Potencia	9 a 12 kw	10 a 13 kw	10 a 14 kw
Rendimento Rendimiento	82%	82%	81%
Consumo Consumo	2.8 kg	2.9 kg	3.2 kg
Carga Recomendada Carga Recomendada	2.6 kg	2.9 kg	3.2 kg
Ventilador Ventilador	Man./Auto. 2 vel.	Man./Auto. 2 vel.	Man./Auto. 2 vel.
Peso Peso	97 kg	107 kg	117 kg
Volume de Aquecimento Volumen de Calentamiento	324 m <sup>3</sup>	337 m <sup>3</sup>	363 m <sup>3</sup>
Dimensões Dimensiones	690 x 548 x 350 mm	790 x 548 x 350 mm	890 x 548 x 350 mm

### CLASSE ENERGÉTICA CLASSE DE ENERGIA

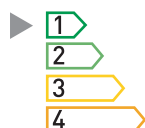





## LISBOA 900 DF EA

Este modelo destaca-se pela sua dupla face, que permite aquecer em simultâneo dois ambientes. Equipamentos com design moderno e requintado, com um toque especial em inox na porta e no puxador. Os recuperadores BLACK SERIES têm uma ampla visão de chama, mantendo baixo consumo de lenha, com elevado rendimento. A tripla combustão garante uma chama perfeita e controlada. Os ventiladores são tangenciais de elevado desempenho e silenciosos, com duas velocidades, para melhorar o seu conforto. A entrada de ar do exterior direta ao recuperador vai beneficiar a qualidade do ar da sua habitação, evitando problemas de funcionamento por depressão.

Este modelo puede calentar dos espacios interiores de forma simultánea gracias a su doble cara. Equipos de diseño moderno y refinado, con un toque especial en inox en la puerta y manilla. Los recuperadores BLACK SERIES tienen una amplia visión de la llama, manteniendo un bajo consumo de leña, con elevada fuente de calor. La combustión triple garantiza una llama perfecta y controlada. Los ventiladores son tangenciales de elevado desempeño y silenciosos, con dos velocidades para mejorar el confort. La entrada de aire exterior directamente hacia el recuperador va beneficiar la calidad del aire del hogar y evitar problemas de funcionamiento por vacío.

### CARACTERÍSTICAS: LISBOA 900 DF EA

Combustível Combustible	Lenha Leña
Potência Potencia	10 a 14 kw
Rendimento Rendimiento	80 %
Consumo Consumo	3.4 kg
Carga Recomendada Carga Recomendada	3.2 kg
Ventilador Ventilador	Man./Auto. 2 vel.
Peso Peso	142 kg
Volume de Aquecimento Volumen de Calentamiento	351 m <sup>3</sup>
Dimensões Dimensiones	890 x 548 x 430 mm

### CLASSE ENERGÉTICA CLASSE DE ENERGIA

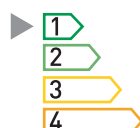







## FARO 800 EA

Equipamento de design clássico, mas intemporal, com tecnologia de elevado rendimento. Sistema de tripla combustão; garante uma combustão perfeita, controlada e uma chama bonita. Utilizamos ventiladores tangenciais de elevado desempenho e silenciosos, com duas velocidades de ventilação para melhorar o seu conforto. Os recuperadores BLACK SERIES têm uma entrada de ar para a combustão do exterior que beneficia a qualidade do ar da sua habitação e evita problemas de funcionamento por depressão.

Equipo de diseño clásico, todavía intemporal, con tecnología de elevado rendimiento. Sistema de tripla combustión que garantiza una combustión perfecta, controlada y una llama bonita. Utilizamos ventiladores tangenciales con elevado desempeño además de silenciosos, con dos velocidades de ventilación para mayor comodidad. Los recuperadores BLACK SERIES tienen una entrada de aire para la combustión del exterior, que beneficia la calidad del aire del hogar y evita problemas de funcionamiento por depresión.

CARACTERÍSTICAS:	FARO 500 EA	FARO 600 EA	FARO 700 EA	FARO 800 EA	FARO 900 EA
Combustível Combustible	Lenha Leña	Lenha Leña	Lenha Leña	Lenha Leña	Lenha Leña
Potência Potencia	6 a 9 kw	7 a 10 kw	9 a 12 kw	10 a 13 kw	10 a 14 kw
Rendimento Rendimiento	82%	82%	82%	82%	81%
Consumo Consumo	2.5 kg	2.7 kg	2.8 kg	2.9 kg	3.2 kg
Carga Recomendada Carga Recomendada	2.4 kg	2.5 kg	2.6 kg	2.9 kg	3.2 kg
Ventilador Ventilador	Man./Auto. 2 vel.	Man./Auto. 2 vel.	Man./Auto. 2 vel.	Man./Auto. 2 vel.	Man./Auto. 2 vel.
Peso Peso	78 kg	89 kg	96 kg	106 kg	116 kg
Volume de Aquecimento Volumen de Calentamiento	294 m <sup>3</sup>	312 m <sup>3</sup>	324 m <sup>3</sup>	337 m <sup>3</sup>	363 m <sup>3</sup>
Dimensões Dimensiones	500 x 548 x 350 mm	600 x 548 x 350 mm	690 x 548 x 350 mm	790 x 548 x 350 mm	890 x 548 x 350 mm

### CLASSE ENERGÉTICA CLASSE DE ENERGIA

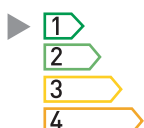





## FARO 900 DF EA

Com este modelo pode aquecer dois ambientes ao mesmo tempo graças à sua dupla face.

Equipamento de design clássico, mas intemporal, com tecnologia de elevado rendimento. Sistema de tripla combustão; garante uma combustão perfeita, controlada e uma chama bonita. Utilizamos ventiladores tangenciais de elevado desempenho e silenciosos, com duas velocidades de ventilação para melhorar o seu conforto. Os recuperadores BLACK SERIES têm uma entrada de ar para a combustão do exterior que beneficia a qualidade do ar da sua habitação e evita problemas de funcionamento por depressão.

Con este modelo se puede calentar dos espacios interiores de forma simultánea gracias a su doble cara.

Equipo de diseño clásico, todavía intemporal, con tecnología de elevado rendimiento. Sistema de tripla combustión que garantiza una combustión perfecta, controlada y una llama bonita. Utilizamos ventiladores tangenciales con elevado desempeño además de silenciosos, con dos velocidades de ventilación para mayor comodidad. Los recuperadores BLACK SERIES tienen una entrada de aire para la combustión del exterior, que beneficia la calidad del aire del hogar y evita problemas de funcionamiento por depresión.

CARACTERÍSTICAS:	FARO 600 DF EA	FARO 900 DF EA
Combustível Combustible	Lenha Leña	Lenha Leña
Potência Potencia	7 a 10 kw	10 a 14 KW
Rendimento Rendimiento	80 %	80 %
Consumo Consumo	2.9 kg	3.4 kg
Carga Recomendada Carga Recomendada	2.9 kg	3.2 kg
Ventilador Ventilador	Man./Auto. 2 vel.	Man./Auto. 2 vel.
Peso Peso	105 kg	141 kg
Volume de Aquecimento Volumen de Calentamiento	295 m <sup>3</sup>	351 m <sup>3</sup>
Dimensões Dimensiones	600 x 548 x 430 mm	890 x 548 x 430 mm

### CLASSE ENERGÉTICA CLASSE DE ENERGIA

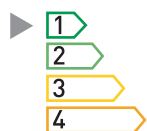





## LISBOA SL 800 EA

Estes equipamentos, além da sua vertente funcional, que garante o aquecimento eficiente do ambiente onde se inserem, são ainda um elemento de decoração e, por isso dedicámos especial atenção ao design, de forma a que os ambientes saiam visualmente enriquecidos. Este é um modelo BLACK SERIES com linhas de tendência minimalista e "clean" e, assim, esta salamandra traduz a eficiência do equipamento de forma distinta e sofisticada.

Estos equipos, además de su funcionalidad, la cual garantiza el calentamiento eficaz del ambiente donde se encuentran, son también elemento de decoración y, por ello, hemos dedicado una atención especial a su diseño, de manera que los ambientes resulten visualmente enriquecidos. Este es un modelo BLACK SERIES con líneas de tendencia minimalista y "clean". Esta estufa traduce la eficiencia del equipo de modo distinto y sofisticado.

CARACTERÍSTICAS:	LISBOA SL 700 EA	LISBOA SL 800 EA	LISBOA SL 900 EA
Combustível Combustible	Lenha Leña	Lenha Leña	Lenha Leña
Potência Potencia	9 a 12 kw	10 a 13 kw	10 a 14 kw
Rendimento Rendimiento	82 %	82 %	81%
Consumo Consumo	2.8 kg	2.9 kg	3.2 kg
Carga Recomendada Carga Recomendada	2.6 kg	2.9 kg	3.2 kg
Ventilador Ventilador	Man./Auto. 2 vel.	Man./Auto. 2 vel.	Man./Auto. 2 vel.
Peso Peso	181 kg	203 kg	225 kg
Volume de Aquecimento Volumen de Calentamiento	324 m <sup>3</sup>	337 m <sup>3</sup>	363 m <sup>3</sup>
Dimensões Dimensiones	790 x 960 x 430 mm	890 x 960 x 430 mm	990 x 960 x 430 mm

### CLASSE ENERGÉTICA CLASSE DE ENERGIA

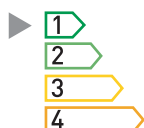





## FARO SL 500 EA

Tal como os nossos recuperadores, as salamandras pretendem aquecer ambientes, mas também decorá-los. Esta nova salamandra da BLACK SERIES enquadra a eficiência dum sistema de ventilação e aquecimento num novo design clássico e elegante, de que resulta uma atmosfera de conforto e bem-estar.

Tal como nuestros recuperadores, las estufas pretenden calentar los espacios, mas también decorarlos. Esta nueva estufa de BLACK SERIES encuadra la eficiencia de un sistema de ventilación e calefacción en un nuevo diseño clásico y elegante, do lo que resulta un ambiente de confort y bienestar.

CARACTERÍSTICAS:	FARO SL 500 EA	FARO SL 600 EA	FARO SL 700 EA	FARO SL 800 EA	FARO SL 900 EA
Combustível Combustible	Lenha Leña	Lenha Leña	Lenha Leña	Lenha Leña	Lenha Leña
Potência Potencia	6 a 9 kw	7 a 10 kw	9 a 12 kw	10 a 13 kw	10 a 14 kw
Rendimento Rendimiento	82 %	82 %	82 %	82 %	81 %
Consumo Consumo	2.5 kg	2.7 kg	2.8 kg	2.9 kg	3.2 kg
Carga Recomendada Carga Recomendada	2.4 kg	2.5 kg	2.6 kg	2.9 kg	3.2 kg
Ventilador Ventilador	Man./Auto. 2 vel.	Man./Auto. 2 vel.	Man./Auto. 2 vel.	Man./Auto. 2 vel.	Man./Auto. 2 vel.
Peso Peso	136 kg	163 kg	180 kg	202 kg	224 kg
Volume de Aquecimento Volumen de Calentamiento	294 m <sup>3</sup>	312 m <sup>3</sup>	324 m <sup>3</sup>	337 m <sup>3</sup>	363 m <sup>3</sup>
Dimensões Dimensiones	590 x 960 x 430 mm	690 x 960 x 430 mm	790 x 960 x 430 mm	890 x 960 x 430 mm	990 x 960 x 430 mm

### CLASSE ENERGÉTICA CLASSE DE ENERGIA

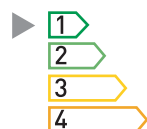







SALAMANDRAS ESTUFAS



ACABAMENTOS ACABADOS

---



ACABAMENTOS EM PEDRA, CORTEN E VIDRO ACABADOS EN PIEDRA, CORTEN Y CRISTAL

---



VISTA DETALHADA  
VISTA DETALLADA

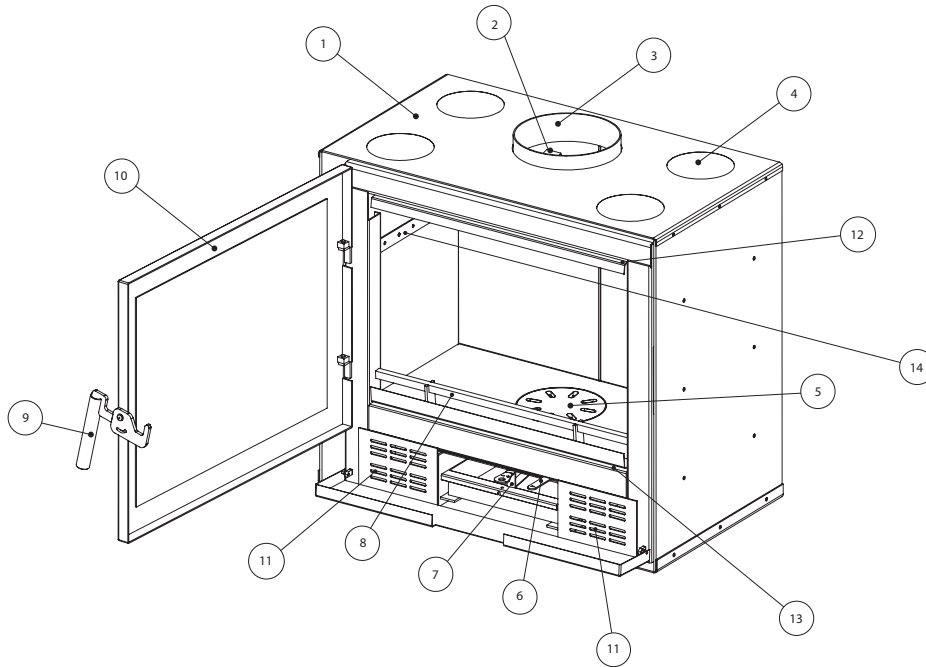

1. CARTÉR  
1. CÁRTER

2. DEFLETORES  
2. DEFLETORES

3. SÁIDA DE GASES  
3. SALIDA DE HUMOS

4. SÁIDA SUPLEMENTAR DE AR QUENTE  
4. SALIDA ADICIONAL DE AIRE CALIENTE

5. GRELHA DE CINZAS  
5. PARRILLA DE CENIZAS

6. AIRWASH  
6. AIRWASH

7. REGISTO PRIMÁRIO DE ADMISSÃO DE AR  
7. REGISTRO DE AIRE PRIMARIO

8. RETENTOR DE LENHA  
8. RETENEDOR DE LEÑA

9. FECHO DE ABERTURA PORTA  
9. CIERRE DE PUERTA

10. PORTA  
10. PUERTA

11. VENTILADORES  
11. VENTILADORES

12. 13. LIMPEZA DO VIDRO  
12. 13. LIMPIEZA DEL CRISTAL

14. TRIPLA COMBUSTÃO  
14. COMBUSTIÓN TRIPLE

# INFORMAÇÃO TÉCNICA RECUPERADORES

## INFORMACIÓN TÉCNICA RECUPERADORES

LISBOA 700 EA

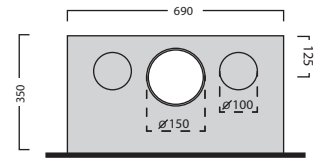
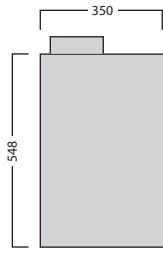
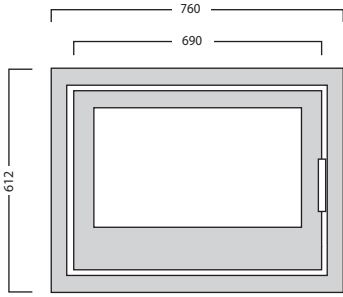

LISBOA 800 EA

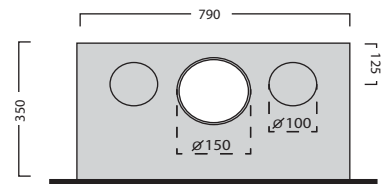
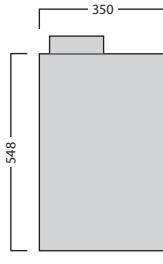
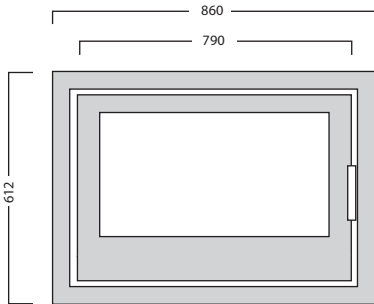

LISBOA 900 EA

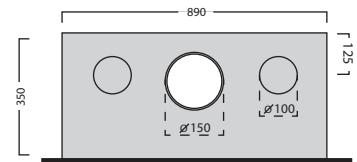
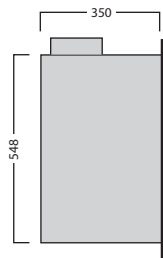
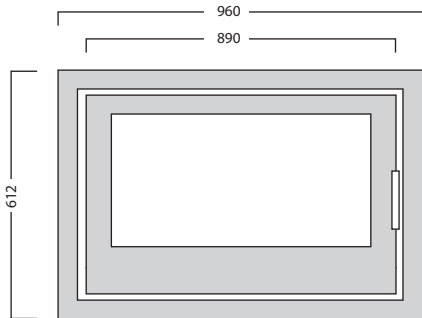

LISBOA 900 DF

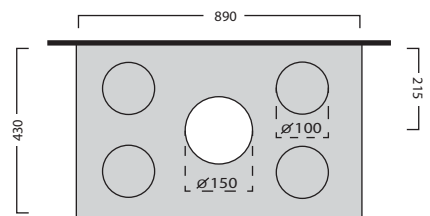
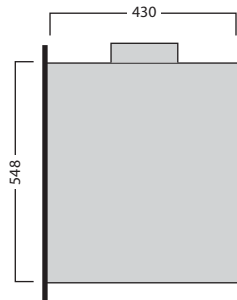
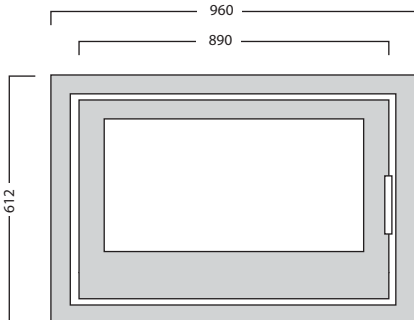

FARO 500 EA

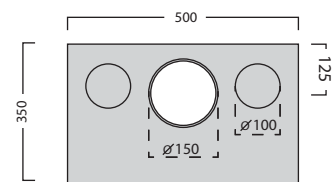
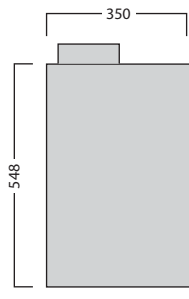
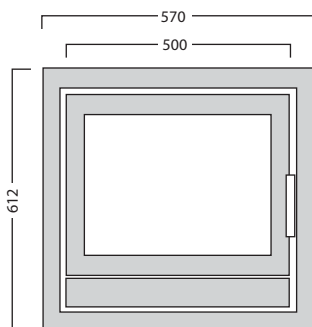

FARO 600 EA

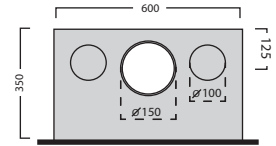
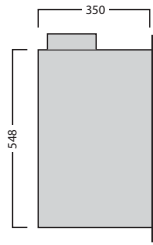
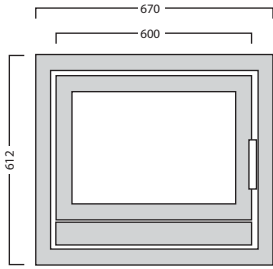

FARO 600 DF EA

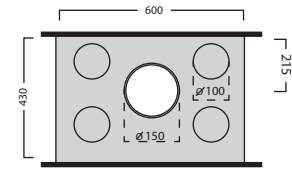
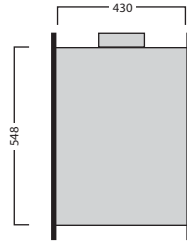
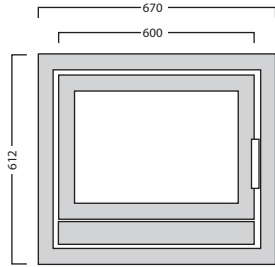

FARO 700 EA

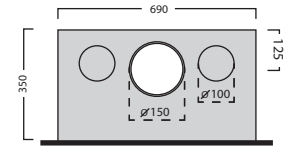
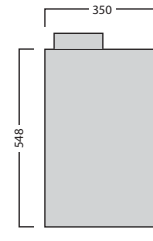
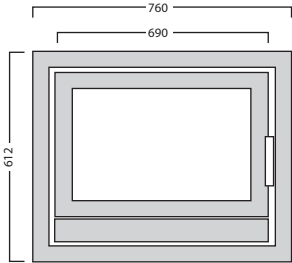

FARO 800 EA

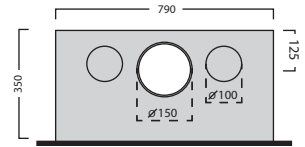
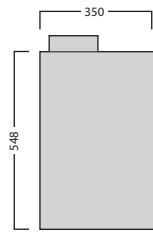
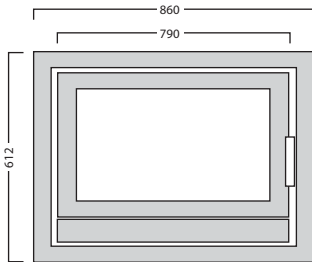

FARO 900 EA

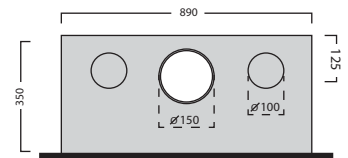
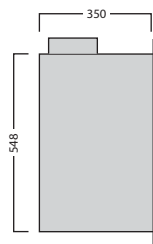
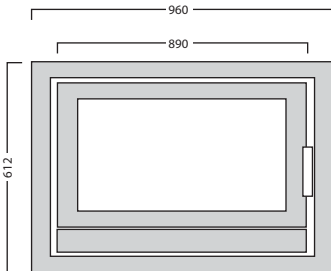

FARO 900 DF EA

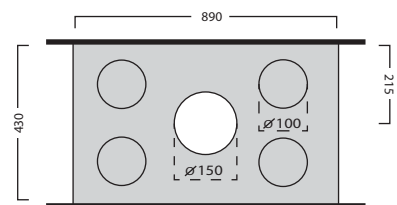
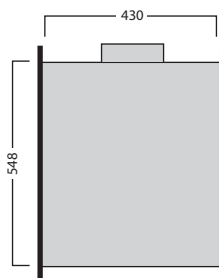
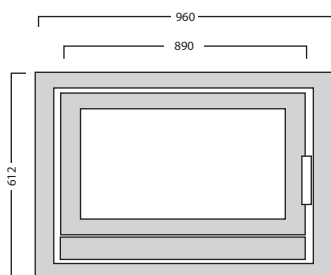

# INFORMAÇÃO TÉCNICA SALAMANDRAS

## INFORMACIÓN TÉCNICA ESTUFAS

LISBOA SL 700

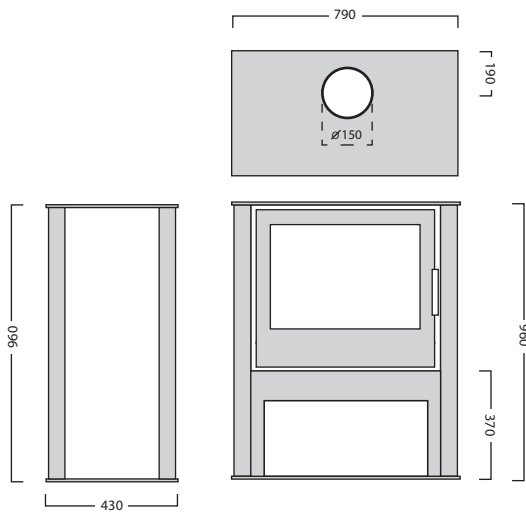

LISBOA SL 800

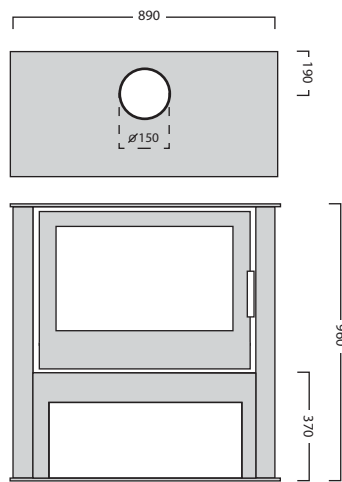

LISBOA SL 900

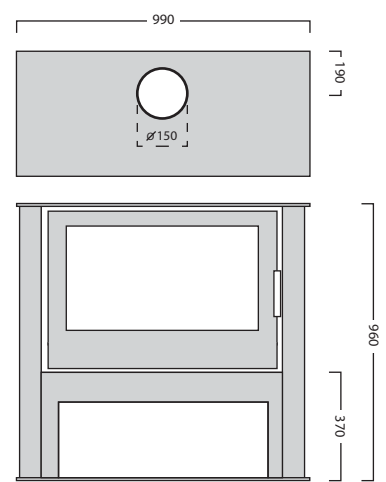

FARO SL 500

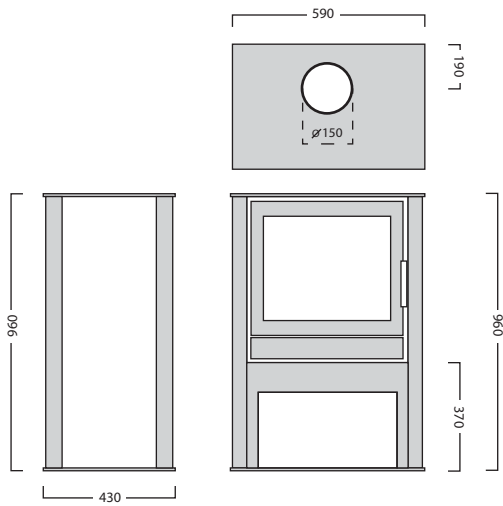

FARO SL 600

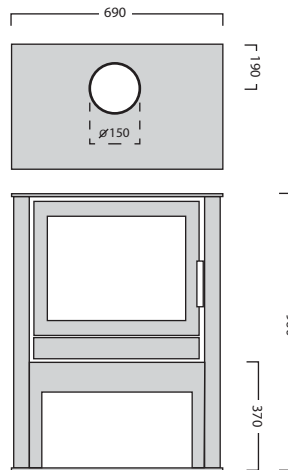

FARO SL 700

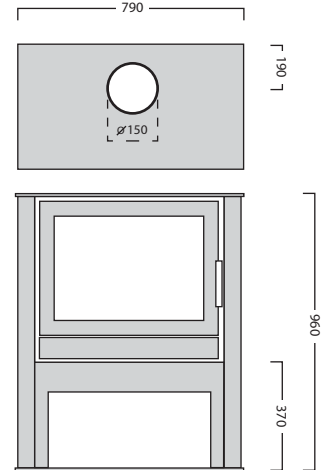

FARO SL 800

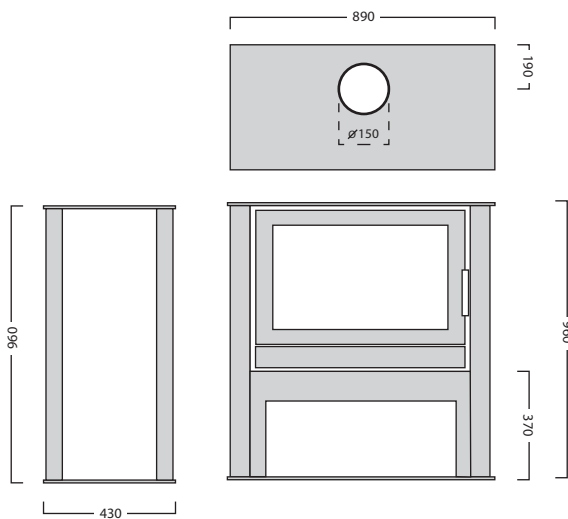

FARO SL 900

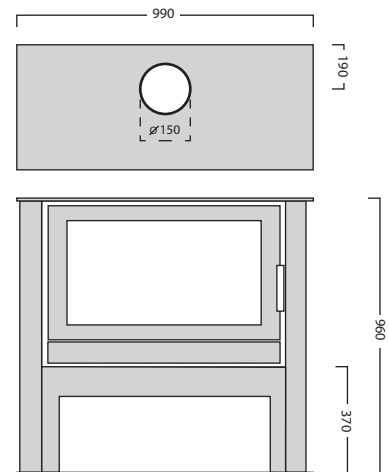



OPCIONAIS  
OPCIONALES

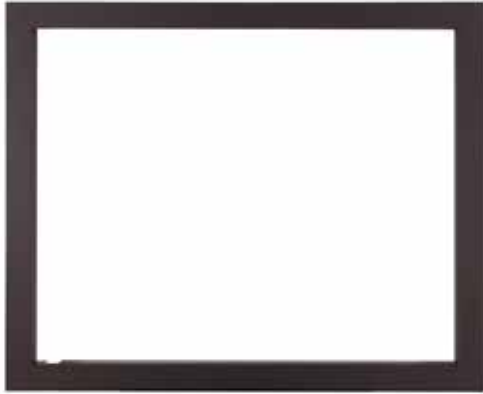

ARO QUADRO SM  
MARCO CUADRO SM



ARO SMV VIDRO  
MARCO CUADRO SMV CRISTAL

MEDIDAS DOS AROS  
MEDIDAS DE LOS MARCOS

SM 500 - 570 x 625 x 40 mm  
SM 600 - 670 x 625 x 40 mm  
SM 700 - 760 x 625 x 40 mm  
SM 800 - 860 x 625 x 40 mm  
SM 900 - 960 x 625 x 40 mm

DISPONÍVEIS PARA TODOS OS MODELOS DE RECUPERADORES  
DISPONIBLES EN TODOS LOS MODELOS DE RECUPERADORES

---

Via Central de Milheirós, 380  
4475-330 Maia  
Tel. 229 600 330 Tlm. 939 600 330  
Fax. 229 600 329  
E-mail: geral@termofoc.com  
GPS: 41.223946, -8.5846222



[www.termofoc.com](http://www.termofoc.com)